

The study of the method of the direct torque control based on space vector pulse width modulation

Ruan Shihao, LIU Weiting, Wei Haifeng, Yan Pengyu, Yao Jinyi, Chen Jiaqi

(School of Electrical and Information, Jiangsu University of Science and Technology, Zhenjiang 212003, China)

Abstract: The paper expounds the mathematical model of permanent magnet synchronous motor, which introduces the general principle of the direct torque control and the space vector pulse width modulation. In the MATLAB/simulink environment, the mathematical model of permanent magnet synchronous motor sets up a simulation model of the direct torque control which based on the theory of SVPWM. Each step and process of the simulation model is introduced in detail and finally the simulation result is obtained. The simulation result shows that the direct torque control system which based on the theory of SVPWM has a constant switch frequency, can reduce the torque ripple greatly, and improves the current waveform and flux linkage waveform. So it makes the system have a better dynamic and static performance and also verify the feasibility and effectiveness of the plan.

Key words: Permanent magnet synchronous motor; Direct torque control; SVPWM

0 INTRODUCTION

With the rapid development of power electronics technology, motor speed regulation theory and microelectronics technology, as well as the continuous change and update of permanent magnet material, the frequency control technology of Permanent Magnet Synchronous Motor has been into the rapid development stage. Permanent Magnet Synchronous Motor are attaining more and more attention due to its simple structure, high moment of inertia ratio, high energy density, high efficiency, high power, low loss, good maintainability and so on. Simultaneously, PMSM has been widely applied into areas of industrial robots, machining centers, electric traction, CNC machine tools and aerospace^[1].

The traditional direct torque control method takes advantage of the hysteresis control. The width is restricted by the frequency of inverter switching, which requires that during one control cycle time, there is only one basic voltage vector working, so it will result in the flux and torque ripple and other issues. Meanwhile, for the SVPWM control, it can synthesize any desired voltage vector, which is able to reduce flux linkage and torque ripple obviously, in order to improve the system's dynamic static performance. This paper introduces the direct torque control program of PMSM on the base of SVPWM, and makes a stimulation study on SIMLINK.

1 Mathematical model of PMSM

Make the following assumptions for

convenient analysis before building mathematical model:

- ① Ignore the effect of core saturation, eddy current and hysteresis;
- ② Permanent magnet rotor without damping winding;
- ③ The three-phase stator winding is completely symmetrical, and the axes of the winding of each phase are spatially different from each other by 120°. The armature resistances and inductance of the stator winding are equal;
- ④ Induced electromotive force (EMF) and air gap magnetic field are distributed along the sine, and regardless of the impact of higher harmonics of the magnetic field.

There are A, B and C three-phase winding on the stator. There are excitation winding f and direct-axis damping winding D on the straight shaft of the rotor, and cross-axis damping winding Q on the cross shaft^[2]. The schematic diagram is shown in

Figure 1.1.

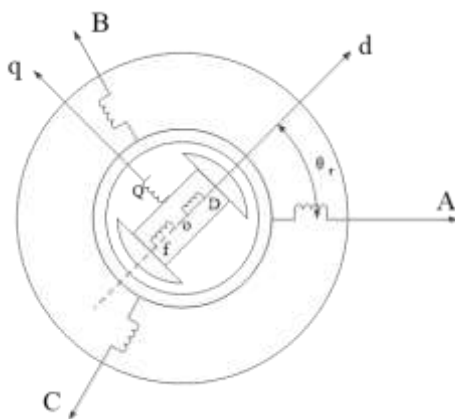

Figure 1.1 synchronous motor schematic

Based on the above assumptions,

mathematical model of three-phase a, b, c stationary coordinate system of PMSM rotor magnetic field:

Stator voltage equation is:

$$\begin{cases} u_a = R_s i_a + p \psi_a \\ u_b = R_s i_b + p \psi_b \\ u_{ca} = R_s i_c + p \psi_c \end{cases} \quad (1-1)$$

u_a, u_b, u_c are instantaneous value of stator winding voltage; i_a, i_b, i_c are instantaneous value of stator winding phase current; ψ_a, ψ_b, ψ_c are instantaneous flux value; p is differential operator, $p = \frac{d}{dt}$; R_s is stator armature phase resistance.

Electromagnetic torque equation:

$$T_e = -n p \psi_f \left[i_a \sin \theta + i_b \sin \left(\theta - \frac{4\pi}{3} \right) \right] \quad (1-2)$$

T_e refers to permanent magnet synchronous motor electromagnetic torque;

Stator flux equation:

$$\begin{cases} \psi_a = L_{aa} i_a + M_{ab} i_b + M_{ac} i_c + \cos \theta \psi_f \\ \psi_b = M_{ba} i_a + L_{bb} i_b + M_{bc} i_c + \cos \left(\theta - \frac{2\pi}{3} \right) \psi_f \\ \psi_c = M_{ca} i_a + M_{cb} i_b + L_{cc} i_c + \cos \left(\theta - \frac{4\pi}{3} \right) \psi_f \end{cases} \quad (1-3)$$

L_{xx} is stator winding inductance; M_{xy}

is mutual inductance between stator winding; ψ_f represents one of abc's; ψ_f is rotor flux linkage; θ is the electrical angle between the rotor axis and the a-axis.

Based on the above assumptions, the mathematical model of PMSM rotor magnetic field in two-phase stationary coordinate system:

Stator voltage equation:

$$\begin{cases} u_\alpha = R_s i_\alpha + L_\alpha p i_\alpha + L_{\alpha\beta} p i_\beta - \omega \psi_f \sin\theta \\ u_\beta = R_s i_\beta + L_\beta p i_\beta + L_{\alpha\beta} p i_\alpha + \omega \psi_f \sin\theta \end{cases} \quad (1-4)$$

Stator flux equation:

$$\begin{cases} \psi_\alpha = \int (u_\alpha - R_s i_\alpha) dt \\ \psi_\beta = \int (u_\beta - R_s i_\beta) dt \end{cases} \quad (1-5)$$

Electromagnetic torque equation:

$$T_e = \frac{3}{2} n_p (\psi_\alpha i_\beta - \psi_\beta i_\alpha) \quad (1-6)$$

u_α, u_β are the $\alpha\beta$ axis component of the stator voltage vector; R_s is stator armature phase resistance; θ is electrical angle of the rotor axis to the a axis; i_α, i_β are the $\alpha\beta$ axis component of the stator current vector; p is differential operator,

$p = \frac{d}{dt}$; ψ_f is rotor flux linkage; L_{xx} is stator winding inductance; T_e refers to the permanent magnet synchronous motor electromagnetic torque; n_p is number of pole pairs; ψ_α, ψ_β are the $\alpha\beta$ axis of the stator flux^[3].

2 Traditional DTC control strategy

2.1 The basic principle of direct torque control

The principle of the traditional DTC control scheme is shown in Figure 2.1.1

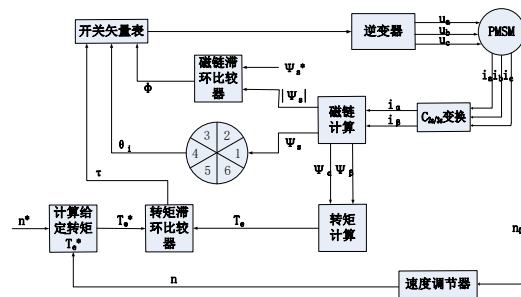

Figure 2.1.1 PMSM direct torque control system schematic

The traditional idea of DTC control is to select the appropriate voltage vector by querying the way of vector switch table to realize the direct control of flux linkage and torque. (The switch voltage vector table shown in Table 1.) Traditional direct torque control scheme is established in the two-phase stationary coordinates $\alpha\beta$. First of all, measure the terminal voltage and the terminal current of the motor; then the transform the coordinate; that is to say, switch the three-phase stationary coordinate

system into the two-phase stationary coordinate system. Use formula (1-5) to calculate the stator flux ψ_s , and use formula (1-6) to calculate the electromagnetic torque T_e , and determine the sector in which the flux is located, as shown in Figure 2.1.2 stator flux vector trajectory. Compare the given flux linkage ψ_s^* and torque T_e^* with the calculated flux linkage $|\psi_s|$ and torque T_e respectively. Get into the hysteresis comparator to control the error. Through the two quantities of the error value and the sector value, you can choose the appropriate voltage space vector, in order to achieve the motor flux and torque direct control^[4].

Table 1 switch voltage vector selection table

$\Delta\psi$	ΔT	I	II	III	IV	V	VI
1	1	U6	U2	U3	U1	U5	U4
	0	U5	U4	U6	U2	U3	U1
0	1	U2	U3	U1	U5	U4	U6
	0	U1	U5	U4	U6	U2	U3

2.2 Direct Torque Control Simulation Experiment

Motor direct torque control is divided into coordinate transformation module, torque, flux estimation module, and hysteresis comparison and switching voltage

meter selection module. Under the Simulink simulation environment of MATLAB, the system simulation model of DTC-based permanent magnet synchronous motor is established according to the control principle of DTC, as shown in Figure 2.2.1.

In the simulation experiment, the parameters of permanent magnet synchronous motor are set as follows: the given motor speed is 100r/min, the sampling period $T_s=1e-005s$, the simulation time of MATLAB is 0.2s, the DC bus voltage is $U_{dc}=310V$. At 0.05s plus step load $1N\cdot m$, pole pairs number $P=2$, stator resistance $R_s=20.51\Omega$, the given value of stator flux $\psi_s^*=0.8wb$, cross-axis inductance $L_d=0.168H$, direct-axis inductance $L_q=0.168H$, torque inertia $J=0.0008kg\cdot m^2$

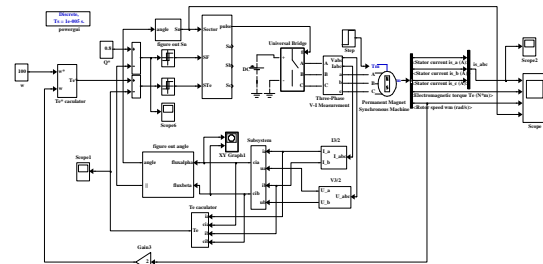

Figure 2.2.1 Permanent Magnet Synchronous Motor Direct Torque System Simulation Model

3 SVM-DTC control strategy

3.1 SVM-DTC control principle

The principle of SVM-DTC control scheme is shown in Figure 3.1.1

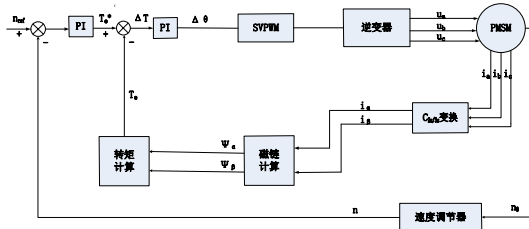

Figure 3.1.1 SVM-DTC control schematic

Compared with the traditional direct torque control scheme, SVM-DTC scheme uses the PI regulator instead of the traditional scheme of torque hysteresis comparator and flux hysteresis comparator. In addition, SVPWM module instead of the query switch table. In the control strategy of SVM-DTC, the motor will issue multiple voltage vectors according to the error of torque and flux linkage in arbitrary control cycle, so as to eliminate the steady-state error of torque and flux linkage, reduce the torque ripple, and let the output waveform become smoother, which in order to obtain better dynamic performance and static performance^[5].

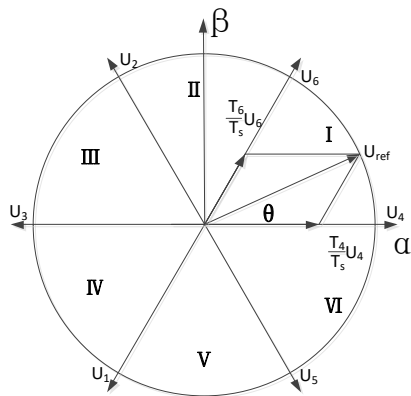

Figure 3.1.3 Basic space voltage vector diagram

Space vector pulse width modulation technology works by using the adjacent two basic voltage space vector of different action time, as shown in Figure 3.1.3. In the figure,

I, II, III, IV, V, VI indicate the sector number where the reference voltage vector U_{ref} is located. U_0, U_7 is zero voltage vector, $U_1 \sim U_6$ is the effective basic voltage vector.

And these eight basic voltage space vector can be any number of different voltage space vector synthesis, so that each cycle can choose a reasonable voltage space vector to compensate for the error of motor torque and stator flux between the observations and reference values^[6]. In order to be able to

compensate for the error ΔT_e between the observed torque value T_e and the torque reference output T_{ref} of the speed regulator, it can take advantage of the PI regulator to calculate the phase angle $\Delta\theta$, the reference

vector ψ_{ref} of the flux linkage, the flux observation value ψ_s and the phase angle θ_{ψ_s} of the observation value, which stator flux required to be added, and then get into the flux compensation module to calculate the flux component of the compensation value $\Delta\psi_{s\alpha}$ and $\Delta\psi_{s\beta}$. Afterwards,

$\Delta\psi_{s\alpha}$ and $\Delta\psi_{s\beta}$, in the voltage space vector calculation module, they can get the stator voltage components $U_{\alpha ref}$ and $U_{\beta ref}$, and finally make use of the SVM algorithm module to output inverter control signal.

SVPM module control schematic diagram shown in Figure 3.1.2

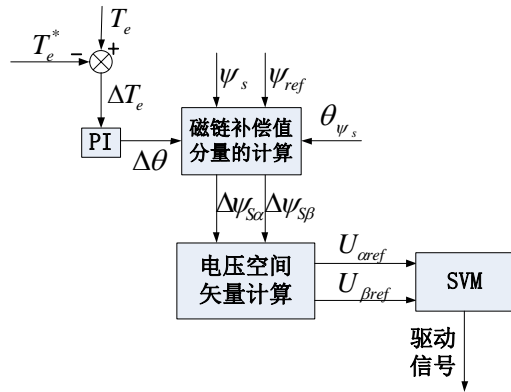

Figure 3.1.2 SVPM module schematic

3.2 Detailed SVM algorithm module

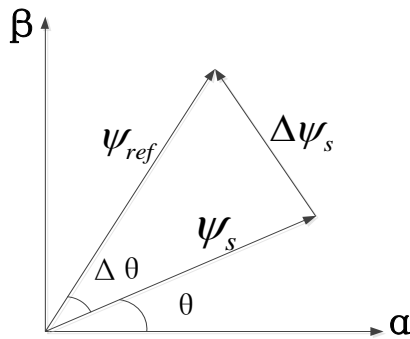

Figure 3.2.1 Stator flux vector

Permanent magnet synchronous motor stator flux vector diagram in Figure 3.2.1, in which ψ_s is the reference value of stator flux vector, ψ_{ref} is the reference value of stator flux vector, $\Delta\psi_s$ is the compensation value of stator flux, ψ_f is the flux vector of rotor permanent magnet, θ is the angle of the stator flux vector

observations and $\Delta\theta$ is the increased angle of stator flux vector phase angle.

The calculation process of reference voltage vector is as follows:

Magnetic chain compensation equation:

$$\begin{cases} \Delta\psi_{s\alpha} = |\psi_{ref}| \sin(\theta + \Delta\theta) - |\psi_s| \sin \theta \\ \Delta\psi_{s\beta} = |\psi_{ref}| \cos(\theta + \Delta\theta) - |\psi_s| \cos \theta \end{cases} \quad (3-1)$$

Reference voltage space vector equation:

$$\begin{cases} U_{\alpha ref} = \frac{\Delta\psi_{s\alpha}}{T_s} + R_s i_{\alpha} \\ U_{\beta ref} = \frac{\Delta\psi_{s\beta}}{T_s} + R_s i_{\beta} \end{cases} \quad (3-2)$$

Stator flux vector equation:

$$\begin{cases} \psi_{s\alpha} = |\psi_{ref}| \cos \theta + L_s i_{\alpha} \\ \psi_{s\beta} = |\psi_{ref}| \sin \theta + L_s i_{\beta} \end{cases} \quad (3-3)$$

In the three-phase inverter circuit, it is assumed that the conduction of the power switch is 1 and the cutoff is 0, we can get the 8 switch status (000 ~ 111) of power switch^[7]. And the corresponding inverter will output 6 motion voltage vectors $U_1 U_2 U_3 U_4 U_5 U_6$ and 2 zero voltage vectors $U_0 U_7$, as shown in Figure 3.2.2. Each vector size is $\frac{2}{3}U_{dc}$, the angle of each adjacent 2 voltage vector is 60° , and the diameter of a hexagon inscribed circle consisting of vector vertices

is $1/\sqrt{3}U_{dc}$.

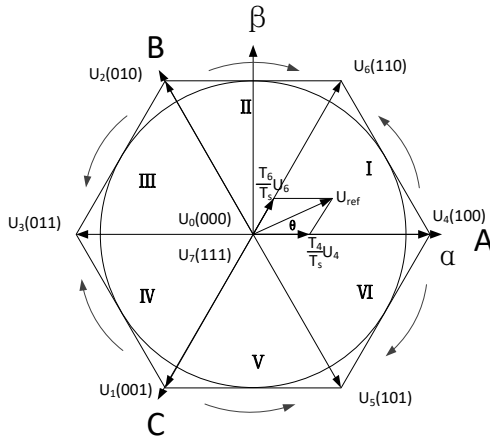

Figure 3.2.2 Reference voltage space vector synthesis diagram

As shown in the above figure, take the the reference voltage vector U_{ref} in the first quadrant of I area as an example, When $|U_{ref}| \leq 1/\sqrt{3}U_{dc}$, then U_{ref} is within the inscribed circle. Therefore, U_{ref} can be synthesized by voltage vector U_4 and zero vector U_0 . At the same time, define T_4 , T_6 , T_0 as the operating time of U_4 , U_6 and zero voltage vector in a cycle period, T_s is the sampling period of system.

In a sampling period, the calculation process of the reference voltage vector in the adjacent two basic voltage vector of the action time T_4, T_6 is shown as follows:

Take I sector as an example, according to the principle of volt-second balance, the relationship between the reference voltage vector U_{ref} and the basic voltage vector U_4 is:

$$U_{ref} = 1/T_s (T_4 U_4 + T_6 U_6) \tag{3-4}$$

$$T_s = T_4 U_4 + T_6 U_6 + T_0 U_0 \tag{3-5}$$

Map the voltage vector to α , β axis, shown in figure 3.2.2, and according to the formula (3-4)(3-5), we can get

$$\begin{cases} U_{\alpha} T_s = T_4 |U_4| + T_6 |U_6| \cos \frac{\pi}{3} \\ U_{\beta} T_s = T_6 |U_6| \sin \frac{\pi}{3} \end{cases} \tag{3-6}$$

according to formula (3-5) (3-6), and

$$U_{dc} = \frac{3}{2} |U_4| = \frac{3}{2} |U_6|, \text{ we can get}$$

$$\begin{cases} T_4 = \frac{T_s}{|U_4|} \left(U_{\alpha} - \frac{U_{\beta}}{\sqrt{3}} \right) = \frac{\sqrt{3} T_s}{2 U_{dc}} (\sqrt{3} U_{\alpha} - U_{\beta}) \\ T_6 = \frac{2 U_{\beta} T_s}{\sqrt{3} |U_6|} = \frac{\sqrt{3} T_s}{U_{dc}} U_{\beta} \\ T_0 = T_s - T_4 - T_6 \end{cases} \tag{3-7}$$

Among them, when $T_4 + T_6 > T$, that is

saturated status, then $T_4 = \frac{T_4 * T_s}{T_4 + T_6}$,

$$T_6 = \frac{T_6 * T_s}{T_4 + T_6}$$

Through the previously calculated size of $U_{\alpha ref}$, $U_{\beta ref}$, you can determine the sector position of spatial voltage reference vector, the operating process is as follows:

Obtained from figure 3.2.2, $U_{\alpha} = U_{ref} \cos\theta$, $U_{\beta} = U_{ref} \sin\theta$, When

U_{ref} is in sector I, the condition is true

$$U_{\beta} > 0, \quad \frac{U_{\beta}}{U_{\alpha}} < \tan \frac{\pi}{3}, \text{ that is,}$$

$$\begin{cases} U_{\beta} > 0 \\ \sqrt{3}U_{\alpha} - U_{\beta} > 0 \end{cases} \quad (3-8)$$

In other sectors, we can get three intermediate variables M_1 , M_2 , M_3 through induction and deduction, if we take advantage of the same method, and M_1 , M_2 , M_3 are:

$$\begin{cases} M_1 = \frac{\sqrt{3}T_s}{U_{dc}} U_{\beta} \\ M_2 = \frac{\sqrt{3}T_s}{2U_{dc}} (\sqrt{3}U_{\alpha} - U_{\beta}) \\ M_3 = \frac{\sqrt{3}T_s}{2U_{dc}} (-\sqrt{3}U_{\alpha} - U_{\beta}) \end{cases} \quad (3-9)$$

Defining variable a, b, c. If $M_1 > 0$, then

a=1, or a=0; if $M_2 > 0$, then b=1, or b=0;

if $M_3 > 0$, then c=1, or c=0. Afterwards, defining $N=4c+2b+a$, then $N=1\sim 7$, We need to define them one by one, thus, we can judge the sector position due to N value, and then get the table 3-1.

Tab.3-1 The relationship between sector position and N.

N	1	2	3	4	5	6
sector s	II	VI	I	IV	III	V

After determine the sector position of

U_{ref} , we need to Use equation (3-7) to calculate the individual action time T_4 , T_6 [8]. The following section describes the relationship between sector position and action time:

Define variable X, Y, Z;

$$\begin{cases} X = \frac{\sqrt{3}T_s}{U_{dc}} U_{\beta} \\ Y = \frac{\sqrt{3}T_s}{2U_{dc}} (\sqrt{3}U_{\alpha} + U_{\beta}) \\ Z = \frac{\sqrt{3}T_s}{2U_{dc}} (-\sqrt{3}U_{\alpha} + U_{\beta}) \end{cases} \quad (3-10)$$

According to equation (3-7), we can get the relationship between T_4 , T_6 and the sectors, as shown in Table 3-2:

Tab.3-2 Duration of voltage vectors in each sector

sec tor s	I	II	III	IV	V	VI
T4	-Z	Z	X	-X	-Y	Y
T6	X	Y	-Y	Z	-Z	-X

After determining the operating time of a sector and the corresponding space voltage vector, We can calculate the value of each corresponding comparator according to PWM modulation principle, and the operation process is as follows:

Defining the the comparison points of trigger pulse PWM1, PWM3, PWM5 as T_{cmp1} , T_{cmp2} , T_{cmp3} . At the same time, define three intermediate variables T_a , T_b , T_c , and their values is

$$\begin{cases} T_a = \frac{1}{4}(T - T4 - T6) \\ T_b = T_a + \frac{1}{2}T4 \\ T_c = T_b + \frac{1}{2}T6 \end{cases} \quad (3-11)$$

We can get the relationship between sectors and comparison points, as shown in Table 3-3.

Tab. 3-3 Computation of Switch Switching Point Values

sec tor s	I	II	III	IV	V	VI
T_{cmp1}	T_a	T_b	T_c	T_c	T_b	T_a

T_{cmp2}	T_b	T_a	T_a	T_b	T_c	T_c
T_{cmp3}	T_c	T_c	T_b	T_a	T_a	T_b

Finally, we can compare the switching times T_{cmp1} , T_{cmp2} , T_{cmp3} , and the triangular wave to get the SVPWM output timing.

3.3 SVPWM control simulation experiment

Under the Simulink simulation environment of MATLAB, the system simulation model of permanent magnet synchronous motor based on SVM-DTC is established according to the control principle of SVPWM, as shown in Figure 3.3.1. The main structure of SVM-DTC control system of permanent magnet synchronous motor includes the calculation of reference voltage vector U_{ref} , the module simulation model is shown in Figure 3.3.2; The judgment of sector U_{ref} , the module simulation model is shown in Figure 3.3.3. The operating time of effective voltage vector and zero voltage vector, the module simulation model shown in Figure 3.3.4. Time allocation of changing switch, the module simulation model shown in Figure 3.3.5.

In the simulation experiment, the parameters of permanent magnet synchronous motor are set as follows: the given motor speed is 100r/min, the sampling period is $T_s=1e-005s$, the simulation time of MATLAB is 0.2s, the bus voltage of DC is $U_{dc}=310V$, In 0.05s, plus step load is $1N \cdot m$,

the number of pole pairs is $P=2$, the stator resistance is $R_s=20.51\Omega$, the set point of Stator flux is $|\psi_{ref}|=0.8\text{wb}$, the cross-axis inductance is $L_d=0.168\text{H}$, the direct-axis inductance is $L_q=0.168\text{H}$, the torque inertia is $J=0.0008\text{kg}\cdot\text{m}^2$.

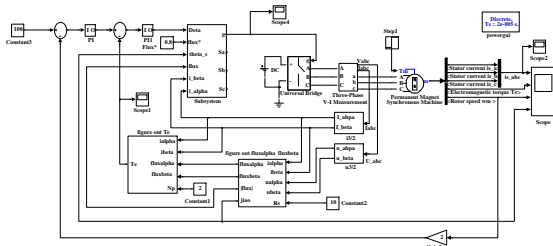

Figure 3.3.1 Permanent magnet synchronous motor SVM-DTC simulation model

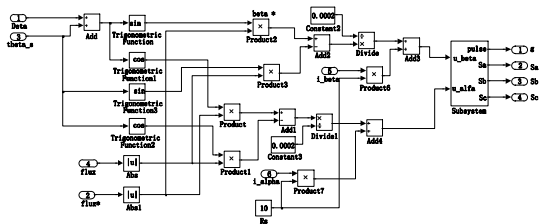

Figure 3.3.2 Calculation of voltage space reference vector

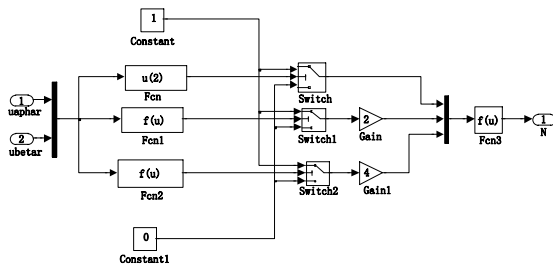

Figure 3.3.3 Calculation of the intermediate variable N

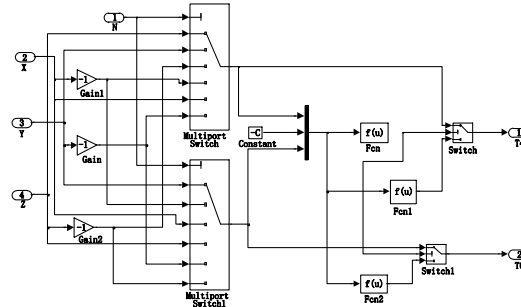

Figure 3.3.4 Calculation of the respective acting time T4, T6 of the basic voltage space vector U4, U6

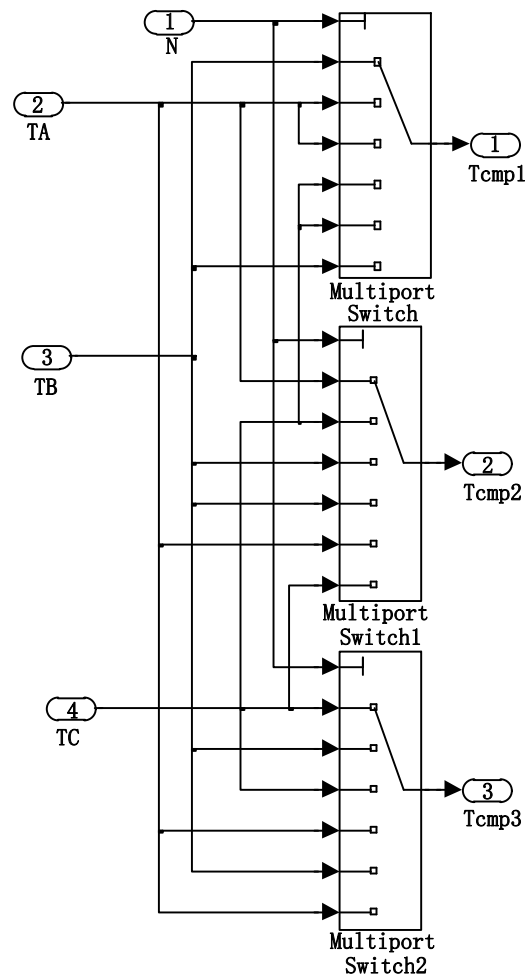

Figure 3.3.5 Calculations of comparator switching points Tcmp1 , Tcmp2 , Tcmp3

4 Simulation results of DTC and SVM-DTC control strategy

Simulation and experimental results are shown in Figure 4.1 ~ Figure 4.4. Figure 4.1 shows the stator flux trajectory under two control schemes. Observing Fig. 4.1 (a) and Fig. 4.1 (b), in both cases the flux trajectories are approximately circular, but in comparison, the flux trajectory under the SVM-DTC scheme is smoother and the flux linkage fluctuations are obviously small. This shows that the use of SVM-DTC program greatly enhances the overall system steady-state performance^[9].

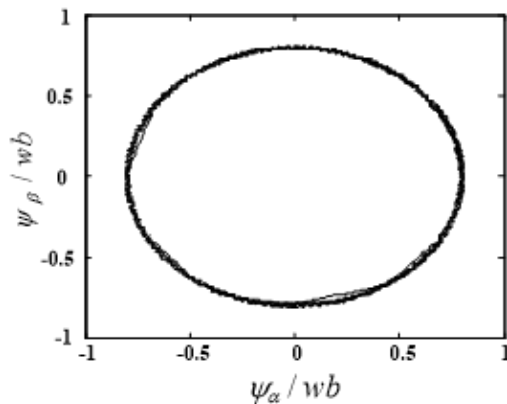

Figure 4.1 (a) DTC flux linkage

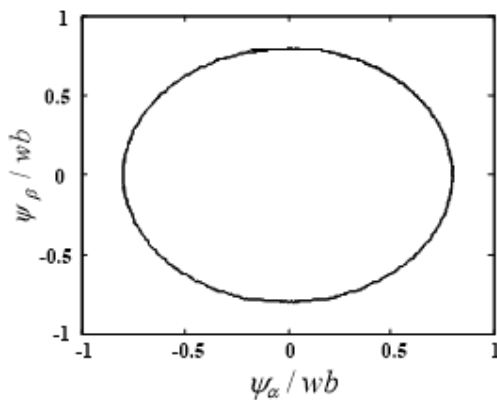

Figure 4.1 (b) SVM-DTC flux trajectory

Figure 4.2 shows the stator phase current waveform. By comparing Fig. 4.1 (a)

and Fig. 4.1 (b), it can be concluded that the start-up current is large and the steady state time is long when the traditional DTC scheme is adopted. However, the stator current of the motor adopting SVM-DTC scheme starts smoothly, the amount of modulation is small, the time achieving steady state is short, and the waveform is closer to the sine wave. And in the SVM-DTC scheme, the stator current is sinusoidal and the current ripple is less than 0.1A.

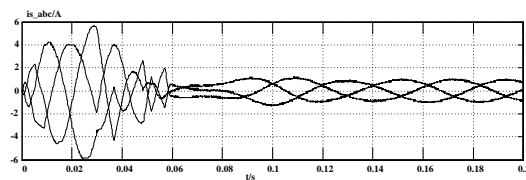

Figure 4.2 (a) DTC stator three-phase current

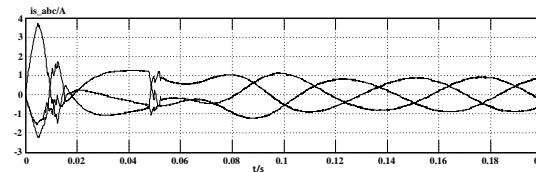

Figure 4.2 (b) SVM DTC stator three-phase current

Figure 4.3 (a) and Figure 4.3 (b) show the electromagnetic torque waveform at steady state. Under the two schemes, the speed of the motor is 0 N·m, at the beginning, and the step load torque is increased by 1N·m at 0.05s. Comparing Figure 4.3 (a) with Figure 4.3 (b), we can see that when the motor is started, the torque waveform of the traditional DTC scheme fluctuates greatly and the torque waveform response time is longer. In the SVM-DTC control scheme, the torque quickly responds to the change of the load torque, that is, the dynamic response of the system is rapid and the overshoot is small with no static error in the steady state^[10].

This shows that the motor has good system performance under SVM-DTC control strategy and the motor can output more stable and accurate torque.

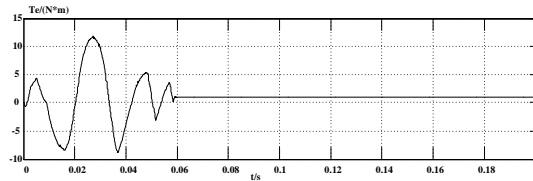

Figure 4.3 (a) DTC torque waveform

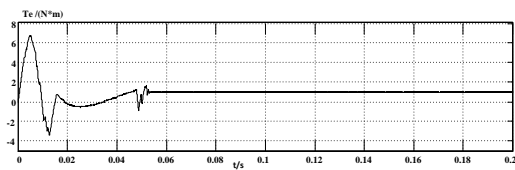

Figure 4.3 (b) SVM-DTC torque waveform

Figure 4.4 shows the motor speed waveforms for a given speed of 100rad/s. Comparing Figure 4.4 (a) and Figure 4.4 (b), we can find that the speed response time of the system adopting SVM-DTC control scheme is shorter. When the load changes from zero to 1N.m at 0.05s, the speed is controlled by a certain overshoot, but it quickly stabilizes well. The system using the traditional DTC control scheme, the speed response time is longer, and when the load torque changes, the speed will fluctuate significantly^[11].

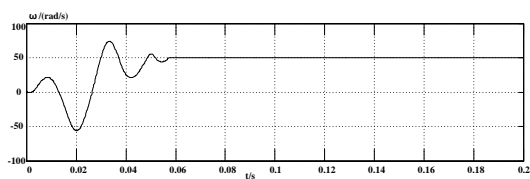

Figure 4.4 (a) DTC speed waveform

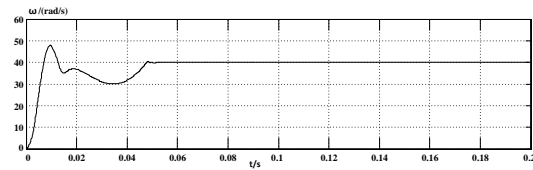

Figure 4.4 (b) SVM-DTC speed waveform

5 Conclusion

From the simulation results in this paper, we can see that in the traditional DTC control strategy, the current, torque and flux ripple are large, and the static dynamic performance is not particularly stable. But the space voltage vector modulation technology, which takes advantage of SVM, use voltage vector to completely compensate the stator flux error, and make use of the PI regulator to replace the traditional hysteresis comparator in order to achieve steady-state flux-free no-static control. Thus it can reduce the flux ripple and torque ripple of the motor, which is able to make the flux locus smoother and the electromagnetic torque tracking faster. Also, the advantage of fast response in the traditional DTC control scheme is maintained.

References and Notes

- [1] Steimel A. Direct self-control and synchronous pulse techniques for high-power traction inverters in comparison[J]. IEEE Trans Ind Electro, 2004, 51(4): 810-820.
- [2] Giuseppe S , Buja Marian , P Kazmierkowski. Direct Torque Control of PWM Inverter-Fed AC Motors-A

- Survey[J]. IEEE Trans Ind Electronics, 2004, 51(4): 744-757.
- [3] Song Jianguo, Chen Quanshi. Research of Electric Vehicle IM Controller Based On Space Vector Modulation Direct Torque Control. 8th ICEMS 2005: 1617-1620.
- [4] Jin Mengjia, Shi Cenwei, Qiu Jianqi, et al. Stator Flux Estimation for Direct Torque Controlled Surface Mounted Permanent Magnet Synchronous Motor Drives over Wide Speed Region. ICEMS, 2005: 350-354.
- [5] Tripathi A, Khambadkone A M, Panda S K. Torque ripple analysis and dynamic performance of a space vector modulation based control method for AC-drives. IEEE Trans Power Electronics, 2005: 485-492.
- [6] Parsa L, Toliyat H A. Sensorless direct torque control of five-phase interior permanent magnet motor drives. 39th IAS, 2004, 2: 992-999.
- [7] Dan Sun, Yikang He, Zhu J G. Sensorless direct torque control for permanent magnet synchronous motor based on fuzzy logic. 4th IPERC, 2004, 3: 1286-1291.
- [8] Linni Jian, Liming Shi. Stability Analysis for Direct Torque Control of Permanent Magnet Synchronous Motors. 8th ICEMS 2005 1672-1675.
- [9] Linni Jian, Liming Shi. Stability Analysis for Direct Torque Control of Permanent Magnet Synchronous Motors. 8th ICEMS 2005 1672-1675.
- [10] Yen-Shin Lai, Fu-San shyu, Yung-Hsin Chang. Novel Loss Reduction Pulsewidth Modulation Technique for Brushless dc Motor Drives Fed by MOSFET Inverter[J]. IEEE Trans on Power Electronics, 2004, 19(6): 1646-1652.
- [11] Yong Liu, Z Q Zhu, David Howe. Direct Torque Control of Brushless DC Drives With Reduced Torque Ripple[J]. IEEE Trans on Ind Application, 2005, 41(2): 599-608.